

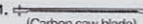

HAN-A TOOLS



Application of each blade

- 
 For cutting wood, plastic, rubber, bamboo, rope, nail, aluminum, PVC, metal, bolt, etc.
- 
 For cutting tile, ceramic, glass bottle, stone, stainless steel, etc.
- 
 For cutting wood, plywood, PVC.

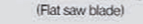
HAN-A TOOLS CO.LTD.

Platinum magic-saw Application of each blade

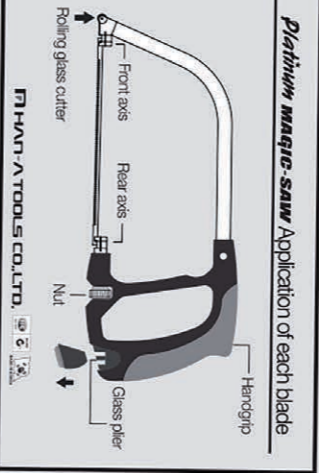

Front axis
Rear axis
Nut
Glass pier
Handgrip
Rolling glass cutter
HAN-A TOOLS CO.LTD.

HAN-A TOOLS

145, Mieum Sandan-3Ro, Gangseo-Gu, Busan, Republic of Korea

TEL. +82-51-714-7200

FAX. +82-51-323-7990



www.magicsaw.com

HAN-A TOOLS

High quality products to clients with competitive prices.

We, HAN-A TOOLS CO.,LTD. Established in 1999, HAN-A TOOLS CO., LTD. has succeeded in domestically producing coping saw blade used in DIY through 3years of R&D.

Hence, we developed and launched the "Magic Saw" (Coping Saw), and have strived to develop hand tools (Magic saw, Magic wrench, Magic sharpener and Magic cutter) and also kitchenware (Double side pan, Barbecue skewer grill and Monster cooker). Through the technology that has acquired 32 overseas and 87 domestic intellectual property rights, we provide our products to 40 countries including U.S.A., Japan, Germany, and France. To become a company endeared by our customers, we put utmost priority to quality and strive for customer satisfaction through trust and sincerity.

We always try to remember when we first started this business, Committed to becoming a leading enterprise and collaboration with our partners and customers based on our motto" to make valuable products that meet our customers".

Exporting 40 countries



CEO Jong Muk, Kim

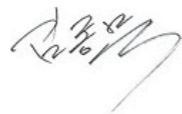

HEADQUARTERS

HAN-A TOOLS CO.,LTD.

145,MIEUM SANDAN-3RO, GANGSEO-GU, BUSAN, KOREA

Tel. +82-51-714-7200 Fax. +82-51-323-7990 E-Mail. hanatools@hanmail.net

HAN-A TOOLS USA

HAN-A TOOLS USA INC.

3660 WILSHIRE BLVD., #1010, LOS ANGELES, CA 90010

Tel. +1-213-381-2231 Fax. +1-213-381-0786

HAN-A TOOLS JAPAN

HAN-A TOOLS JAPAN CO., LTD.

Applause hirokami #403, 3-1-1, Kitamachi, Nerima-ku, Tokyo, 179-0081, JAPAN

Tel. +81-3-6631-4802 Fax. +81-3-6735-4380

PRODUCT LINE

Platinum **MAGIC WRENCH**



MULTI-CUTTER



MULTI-PURPOSE DIAMOND Sharpener



다이아몬드 **MULTI-PURPOSE DIAMOND Sharpener**



MAGIC TACKER



BALLPANG HAMMER
Nonrecoil Ballpang Hammer



MAGIC-SAW Ultra

HAN-A TOOLS

Magic Saw is a handy tool ideal for home, garage, workshop, automotive, school, factory, DIY projects, prototyping, sampling, model building, construction, maintenance, repair, gardening, decoration, advertising, pruning trees, wood working, educational, R&D projects, art & craft, leisure activities. hiking, fishing camping, hunting & can be used by plumbers, artists, carpenters, smith, craftsmen, handymen builders, hobbyists, house wives, children & all family.



Diamond sharpener
sharpen the knives, scissors, sickles, brush cutter, axes, etc.

HA-3100

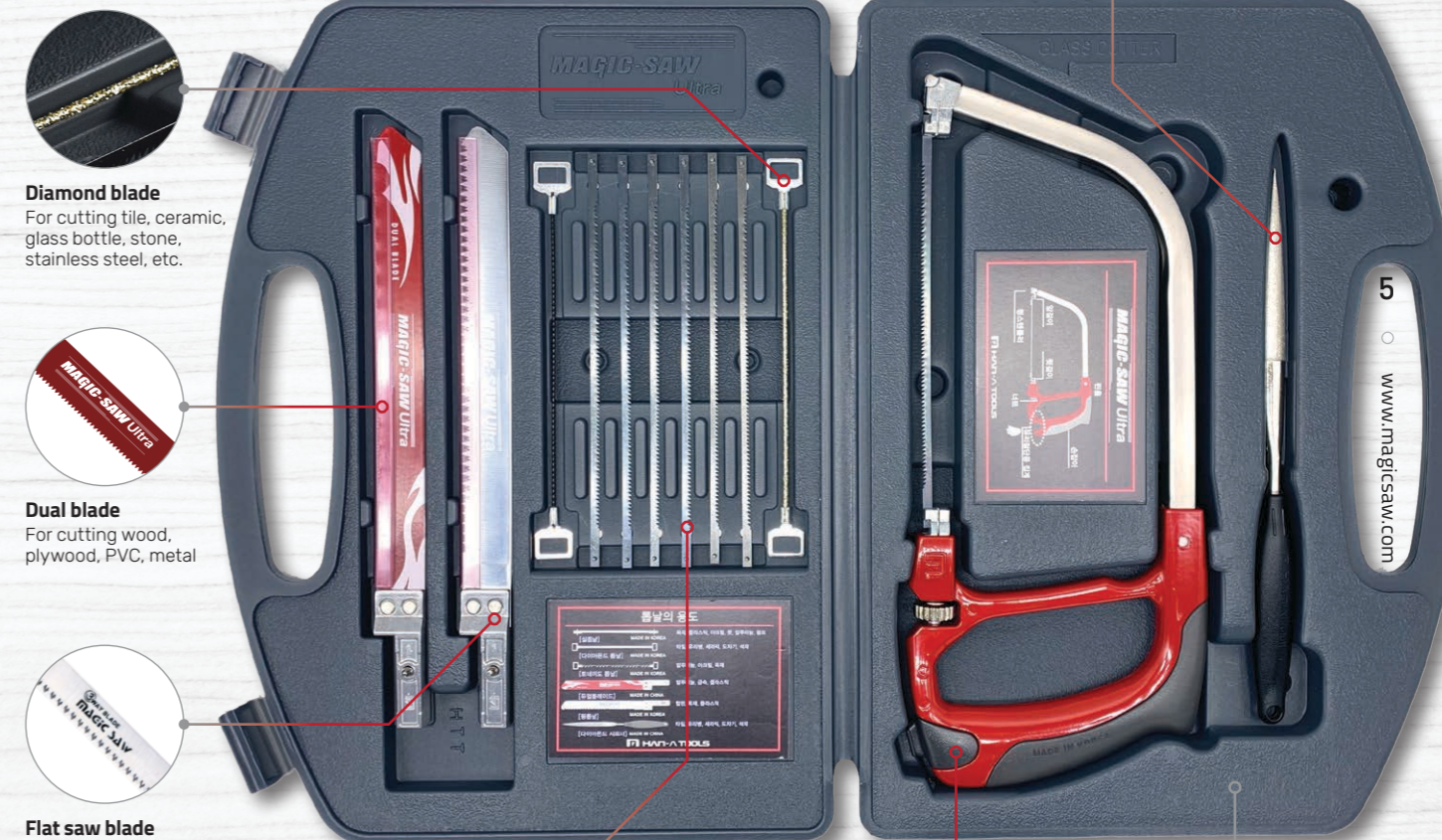

Diamond blade
For cutting tile, ceramic, glass bottle, stone, stainless steel, etc.

Dual blade
For cutting wood, plywood, PVC, metal

Flat saw blade
For cutting wood, plywood, PVC, metal.

Carbon blade
For cutting wood, plastic, rubber, bamboo, rope, nail, aluminum, PVC, metal, bolt, etc.

Glass piler

Body

HA-2100



Platinum **MAGIC-SAW**

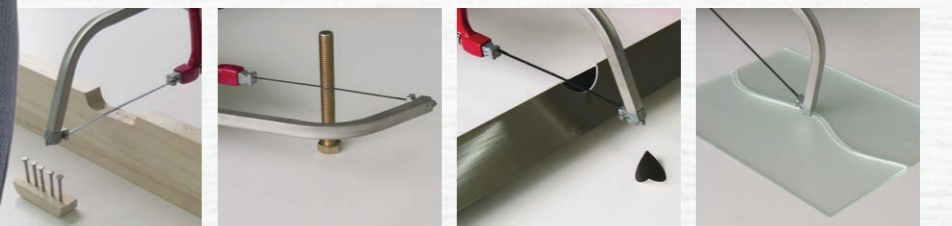

MULTI - PURPOSE ★
MAGIC-SAW GOLD

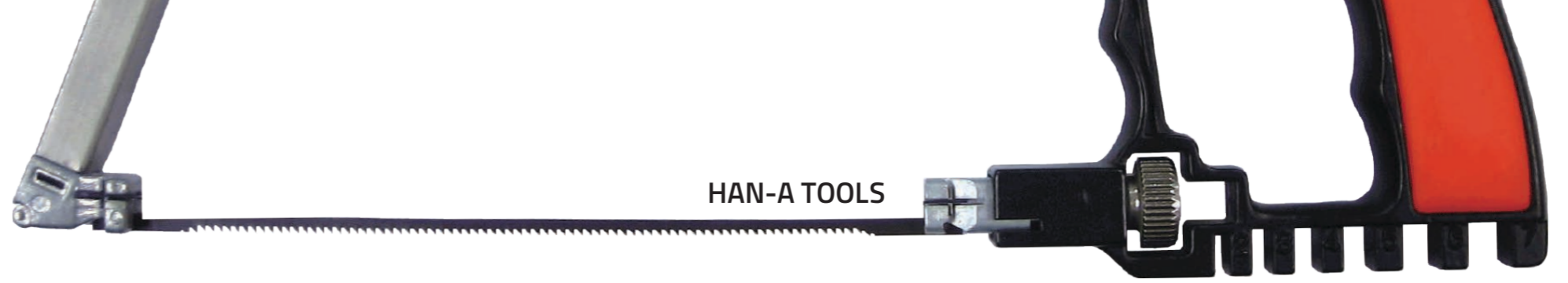

- HA-904**
- Body(square frame + handgrip) 1EA
 - Coping saw blade 5EA
 - Tungsten roller cutter 1EA



- HA-1700**
- Body (square frame + handgrip) 1EA
 - Coping saw blade 6EA
 - Tungsten roller cutter 1EA
 - **Diamond saw blade 1EA**



- HA-904D**
- Body(square frame + handgrip) 1EA
 - Coping saw blade 4EA
 - Tungsten roller cutter 1EA
 - **Diamond saw blade 1EA**



- HA-1100**
- Body (square frame + handgrip) 1EA
 - Coping saw blade 7EA
 - Tungsten roller cutter 1EA
 - Big flat saw blade 1EA
 - **Diamond saw blade 1EA**

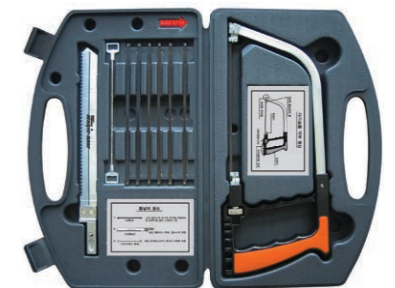

- HA-907D**
- Body(square frame + handgrip) 1EA
 - Coping saw blade 5EA
 - Big flat saw blade 1EA
 - Tungsten roller cutter 1EA
 - **Diamond saw blade 1EA**



- HA-2200**
- Body (square frame + handgrip) 1EA
 - Coping saw blade 6EA
 - Tungsten roller gutter 1EA
 - Big flat saw blade 1EA
 - **Diamond blade 1EA**



- HA-907Bag**
- Body(square frame + handgrip) 1EA
 - Coping saw blade 7EA
 - Big flat saw blade 1EA
 - Tungsten roller cutter 1EA
 - **Diamond saw blade 1EA**

- HA-1000**
- Body (square frame + handgrip) 1EA
 - Coping saw blade 6EA
 - Tungsten roller cutter 1EA
 - Big flat saw blade 1EA
 - **Diamond saw blade 1EA**
 - **Diamond grind blade 1EA**



MULTI-PURPOSE MAGIC-SAW I, II

HAN-A TOOLS

HA-101

- ◆ Body (circular frame + handgrip) 1EA
- ◆ Coping saw blade 4EA



HA-101S

- ◆ Body (circular frame + handgrip) 1EA
- ◆ Coping saw blade 3EA
- ◆ Big flat saw blade 1EA



HA-104

- ◆ Body (Circle frame + handgrip) 1EA
- ◆ Coping saw blades 5EA
- ◆ Big flat saw blade 1EA



HA-105

- ◆ Body (Circle frame + handgrip) 1EA
- ◆ Coping saw blades 4EA



SPARE PART



HA-103B

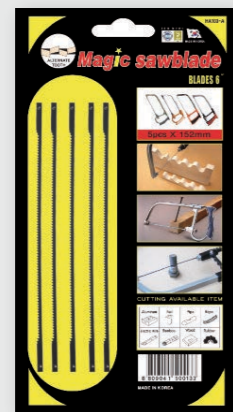

HA-103A



HA-1032R

HA-1034R

HA-1037R



HA-501



HA-601



HA-502(9EA)



HA-602(9EA)

COPING SAW

HAN-A TOOLS

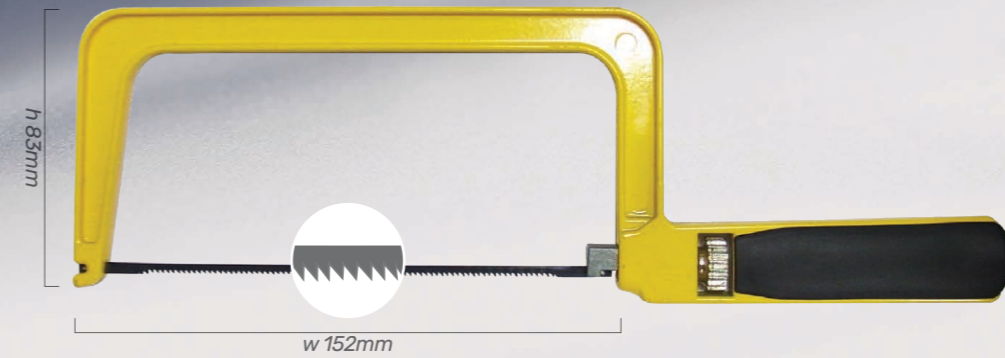

TORNADO SAW

HAN-A TOOLS



MULTI-CUTTER

HAN-A TOOLS

The Advanced Concept Multi Cutter has a saw blade for wood, a tungsten-carbide blade for metal and stone, a sharpener to grind metal or glass and a roll-tip to cut glass plate or tiles all in ONE to the body. It has the very strong advantage that one tool works for various materials. This provides users conveniences, which are the one-touch button pops up the blades, and ergonomic comforts.

ZC-4000



ZC-5000



ZC-4000Bag



ZC-4000BL



MULTI-PURPOSE **DIAMOND** Sharpener

HAN-A TOOLS



PRODUCT

Magic Sharpener - Perfect Tool for sharpening kitchen chief knife & Scissors

Magic Sharpener can sharpen strong materials knives and scissors such as stainless knives and high hardness knives which got heat treatment, as the ingredient is diamond hardness is higher than those tools.

Magic Sharpener in this page has double side of diamond surfaces.
 - Rough surface for first time treatment
 - Fine surface for finishing

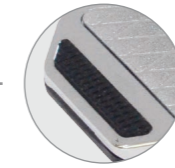
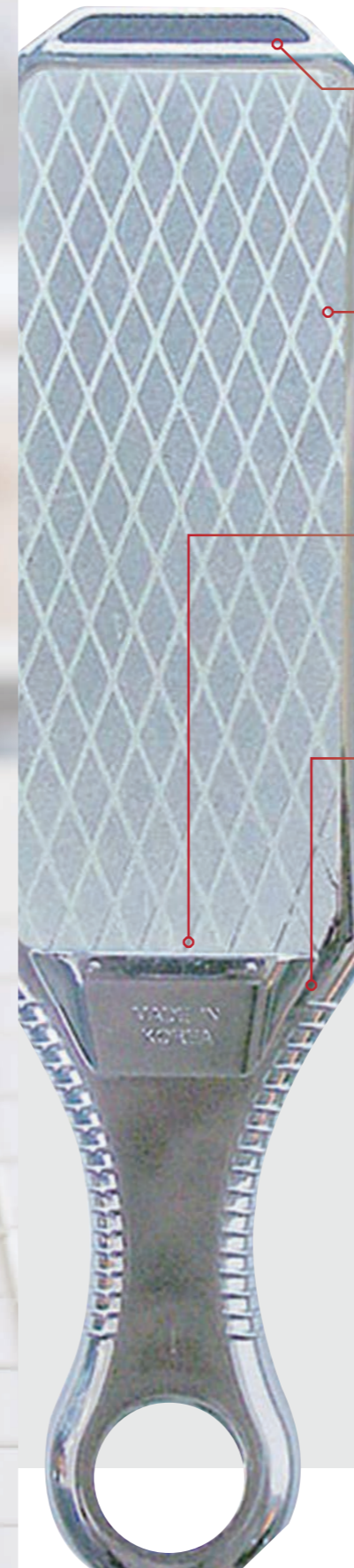

Non-slip pad

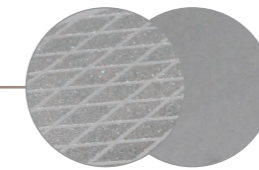

Front (Rough surface)
Back (Smooth surface)

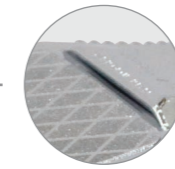

Safety block

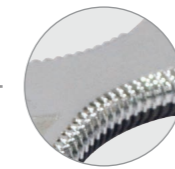

Non-slip Handle

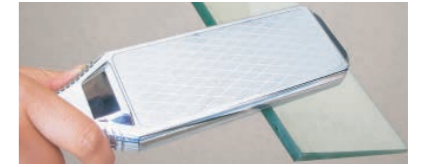

SHA-2W



68mm x 270mm x 33mm

SHA-2W(CR)



68mm x 270mm x 33mm

MULTI-PURPOSE **DIAMOND** Sharpener

HAN-A TOOLS



PRODUCT

The other version of Magic Sharpener

SHA-Bag

62mm x 170mm x 33mm



SHA-Case

62mm x 170mm x 33mm



DSHA-2W

95mm x 227mm x 25mm



SHA-780

Front Side



MAGIC WRENCH

HAN-A TOOLS

9mm ~ 45mm

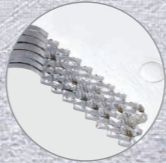

Back Head

16
MAGIC WRENCH

24-45mm

PRODUCT

Magic Wrench is a new concept for tightening or loosening a numerous range of objects from 9 ~ 45mm, due to its double jaws on both ends of the tool. It can hold any size of bolt, nut and even a pipe.

WR-5300



WR-5300DP(8PCS)



WR-8000



WR-8000BAG



WR-7000



Platinum★ MAGIC WRENCH

HAN-A TOOLS

PRODUCT

Platinum Magic Wrench is upgrade version of Magic wrench
The maximum working range got bigger from 45mm to 52mm
and the grip design improved to be more ergonomic

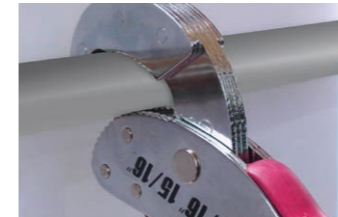

WR-8000

Wrench 45mm 1EA



WR-9000

Wrench 52mm 1EA

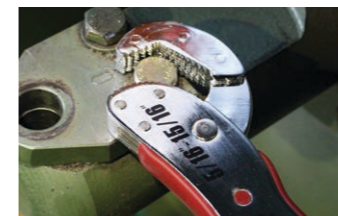

WR-9000HOOK

Wrench 52mm 1EA



HARDENED JAWS



RATCHET SPRING



THREE POINTS GRIP



ERGONOMIC GRIP



RIVET



ANTI SLIP TEETH



BALLPANG HAMMER

Nonrecoil Ballpang Hammer

HAN-A TOOLS

Light, strong, and non-recoil joint-friendly!

♦ Woodworking ♦ Workshop ♦ Automobiles ♦ Metal processing ♦ Interior ♦ Construction

The Hard (Black) Molybdenum heads
Drive nails, Metal Processing, Setting stones positioning articles, Correcting plants or structures, Assembling housings, bending, metal production, Building up machines, emergency uses (breaking windows), Camping uses

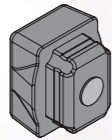

The Mid (Orange) Urethane Mid Head
Woodworking joints, Assembling furniture, working with bricks, Flooring, Repairing roof, Construction with stone blocks, floor flattening, roof molding, tiling, stone construction, stone construction, setting steps with natural stones

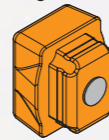

The Soft (White) Urethane Flexible Head
Packing products, floor flattening Assembling softwood, Art projects

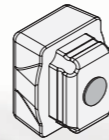

The black heads have great wear-resistance since these include molybdenum powder.

Magnetic heads
PATENT PENDING
No.10-2018-0029235

A special structure in the main body
PATENT PENDING
No.10-2018-0025378

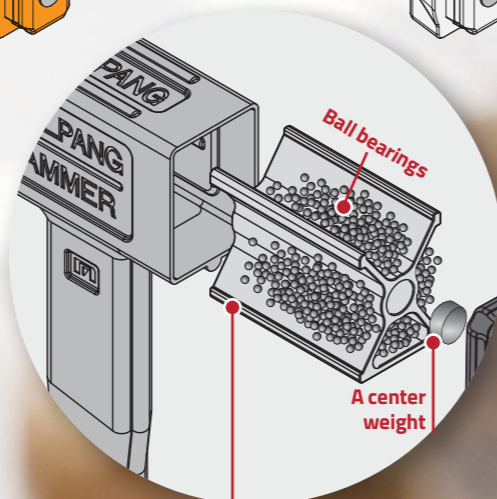

A partition structure for power distribution.
PATENT PENDING
No.10-2018-0030590



PRODUCT

Ballpang hammer non-recoil joint hammer 20,000pcs of bearings will help user's hammering, using gravity. It allows exact and safety working and can be used for various place and circumstances.



BH-200

- ♦ Body 1EA
- ♦ Molybdenum head 1EA
- ♦ Flexible Head 1EA



BH-500

- ♦ Body 1EA
- ♦ Urethane Mid Head 1EA
- ♦ Flexible Head 1EA



BH-800

- ♦ Body 1EA
- ♦ Molybdenum heads 2EA
- ♦ Urethane Mid Heads 2EA
- ♦ Flexible Heads 2EA
- ♦ Exclusive tool 1EA
- ♦ Bag 1EA
- ♦ Pouch 1EA



BH-400

- ♦ Body 1EA
- ♦ Molybdenum head 1EA
- ♦ Urethane Mid Head 1EA
- ♦ Flexible Head 1EA
- ♦ Exclusive tool 1EA



HD-100



Molybdenum Heads 2EA



HD-200



Urethane Mid Heads 2EA

HD-300



Flexible Heads 2EA



**POWER OK!
ONE-TOUCH!**



PRODUCT

It is easy to drive a pin on the wall by one-touch.
The small pin can stand up to 10kg and can be utilized variously as covering the pin with cap or hook. It is applicable to wood, gypsum, plastic, gap between the tiles, MDF, and any where in wooden materials.
It is conveniently used when wanting to drive nails for hanging frame, calender, clock, coat hanger, ornament and etc.

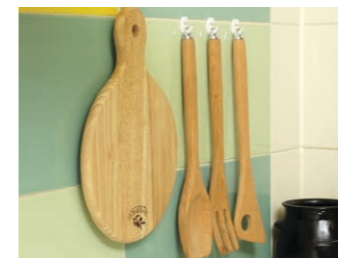

TA-400Bag

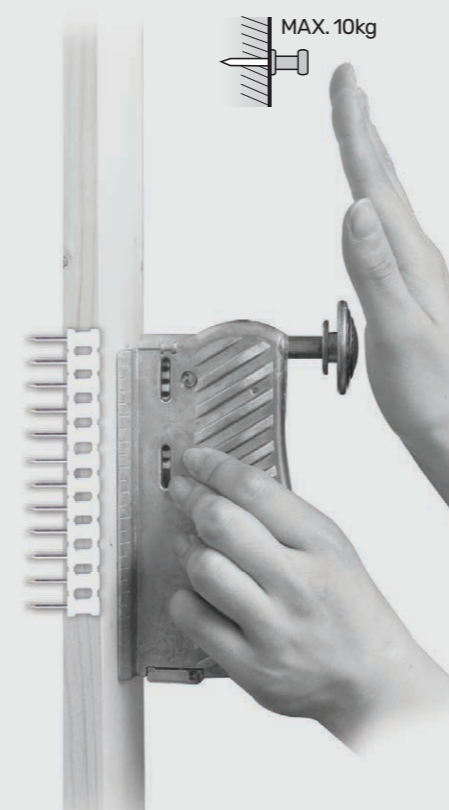

TA-100

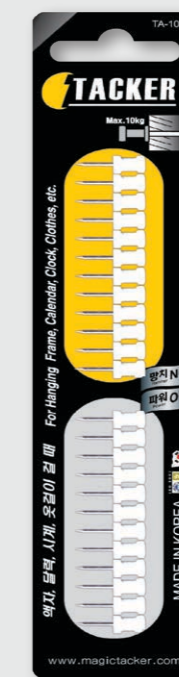

TA-200



MAGIC-SAW AGUR GRIP

HAN-A TOOLS

"Magic Saw Agur Grip" is a name reminiscent of crocodile ('Agur' in Korean) teeth, which don't let go of anything once they bite. The specially designed handle can be easily installed on various saw blades with just one touch.



AG1000



AG2000



24 HAN-A TOOLS CO., LTD.

PRODUCT

The Agur grip is a new-concept tool that can cut various materials such as metal, wood, plastic, aluminum, tile, and glass, depending on the type of saw blade, and it also enables agricultural activities such as gardening and mowing with the additionally configured hoe and sickle.

Carbon wooden saw blade

The carbon woodem saw blade is manufactured using the high-frequency heat treatment "hard impulse method," so the hardness of the teeth is stronger and it does not easily wear down, which means it can be used for a longer time than general saw blades.



Tungsten(Carbide) Saw blade

The tungsten (carbide) saw blade is made of a strong carbide that allows them to cut not only ceramics such as tiles, bricks and glass, but also metals such as stainless steel.



Carbon metal saw blade

The carbon hacksaw blade is functional saw blade mainly used for cutting metal and iron, and it can also be used with a more comfortable up and down sawing motion.



Roller cutter

The roller cutter makes easy to cut glass or tiles, even when it comes to straight curves and semicircles.



Gardening Hoe

The Agur Grip Gardening hoe is at an angle of 30 degrees, so it is easy to work with and can be used for many tasks, such as removing weeds from sidewalk blocks, planting seedlings, planting vegetables, digging sweet potatoes, planting flowers, digging ditches, pounding, and digging for medicinal herbs in the mountains.



Sickle

The Agur Grip sickle has a saw blade, so it has the advantage of allowing you to cut grass without grabbing it. It can be used to cut various kinds of plants, such as grass, garlic chives, and barley (mowing, weed removal, harvesting water parsley).



Rake

The Agur Grip rake is useful for clearing haystacks, weeds and seaweed, and cleaning up fallen leaves, debris, and straw. It's also good for digging up fish and shellfish in tidal flats.

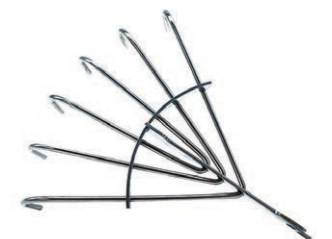

25 www.magic-saw.com

KAKBANG AIR CLEANER

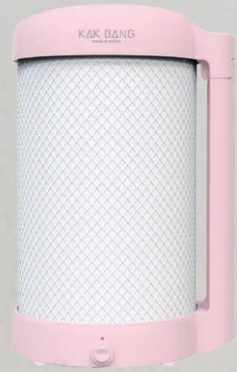

KBR - 200



KBR - 300



KBR - 100

PRODUCT

10 year warranty motor based on 24-hours-a-day use

- Long service life with 24 layers
- Low noise due to the double-sided ball bearing design
- An electricity bill of KRW 616(for 24 hours a day)

Certificate and Test Report



KC Certificate No. (ZB07020-22001A)

Electromagnetic Compatibility Registration No. (R-R-Ha8-KB-100)

Korea Energy Agency Efficiency No. (EC22-00986K)



KCL Filter Test Report KBR-100

KFTL Korea Filter Test Report KBR-100

KCL Equipment Efficiency Management Report KBR-100

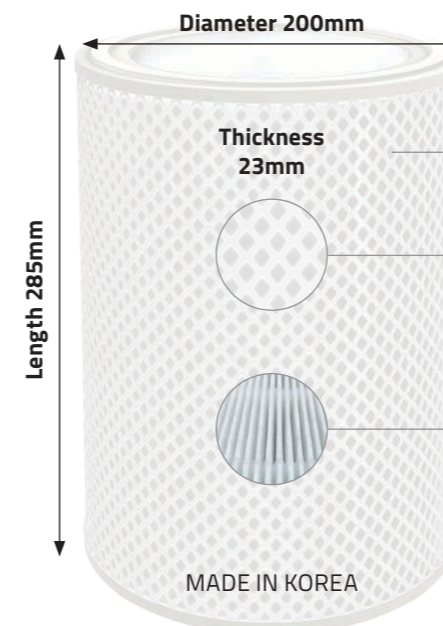

Key Features of the filter

Large-capacity filter thickness 23mm
Length 285mm / Diameter 200mm

Filter net

The filter mesh surrounding the filter primarily catches thick dust.

Particulate filtering Layer

The filter of Kakbang air cleaner is a high-efficiency air purifying filter that has an ability to block a fine particulate matter even 0.3µm until 98.8%.

Manufacturer of filter :
Eco Filtech Co., Ltd. where is a one of major company in filter field